



ZP-EINHAKMONTAGEN  
SCHNELL STABIL PRÄZISE

# 2023 CATALOGUE



[www.zp-einhakmontage.de](http://www.zp-einhakmontage.de)

## Bestellnummernschlüssel für Komplettmontagen Part number key Numéro commande clé pour montage complet

11    2    2    Z    30    802

ZP-Einhakmontage Contra, brüniert!  
ZP Clawmount, Blacked!  
Montage à crochets-ZP Contra brunit

**Bauhöhe=**Distanz zwischen oberkante Waffe und unterkante Zielfernrohr!  
**Building height=** Distance between the top of the action and the bottom of the scopetube!  
**Hauteur de construction=**distance entre arrête supérieur de l'arme et arrête inférieur de la lunette

BH	Code-No.
14 mm	0
15 mm	1
16 mm	2
17 mm	3
18 mm	4
19 mm	5

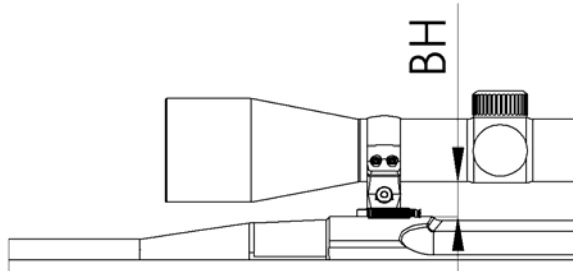

**Kraglänge Schlösschenfuß**  
**Cantilever length**  
**Longueur de col du pied de verrouillage**

Theoretisches Maß  
Theoretical measure  
Mesure théorique

KR	Code-No.
0 mm	0
17 mm	1
26 mm	2
32 mm	3

X=
-0,5mm
16,5mm
25,5mm
31,5mm

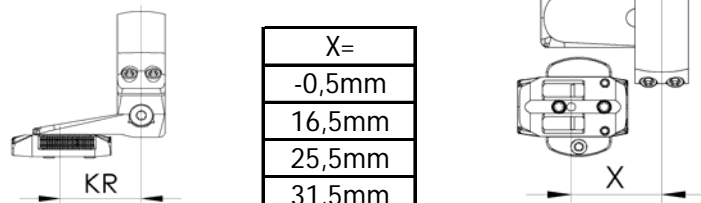

**Zielfernrohr**  
**Riflescope/scope**  
**Lunette**

1"/26 mm

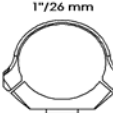

Ø26mm

30 mm

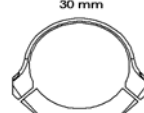

Ø30mm



LM-Prisma



Zeiss ZM/VM-Schiene



Swarovski SR-Schiene



Schmidt&Bender Schiene

Code-No.	26	30	40	45	60	70
----------	----	----	----	----	----	----

Codenummer je nach Modell (siehe Seite 3)!  
Codenumber, depending on model (see page 3)!  
Numéro de code suivant modèle (voir page 3)!

Modell	Code-No.
Anschütz Rep. 1780	802
Anschütz (11mm Schiene)	803
Antonio Zoli-Zoli 1900	305
Benelli Argo	273
Brüner CZ	812
Carl Gustav-2000	194
Carl Gustav-3000	194
Carl Gustav-4000	459
Chapuis Express	810
FN Browning-A-Bolt,Eurobolt	202
FN Browning BARI,BARII,	003
FN Browning-Browning Mauser	004
FN Browning-European	143
FN Browning X-Bolt	212
Haenel SLB 2000	187
Haenel Jaeger 10	806
Heckler & Koch SLB2000	187
Heym SR20	060
Heym SR40	108
Heym SR30	206
Heym SR21	306
Krieghoff DB Drilling	804
Krico 700,900,902	006
Krico 600	006
Mauser K98	010
Mauser M12	010
Mauser 94,96 Nr.<96011999	156
Mauser 94,96 Nr.>96012000	256
Merkel Helix	808
Merkel SR1, Automatic	186
Merkel DB Drilling	804
Remington 700	012
Remington 7400, 7600	074
RWS/Rössler,Titan 6	459
RWS/Rössler,Titan 16	814
Sabatti Rover	023
Sako Finnwolf	070
Sako Vixen L461	214
Sako Forester L579	214
Sako Finnbear L61R	214
Sako 85	214
Sauer 80,90,92	015
Sauer 200	059
Sauer 202 Medium	659
Sauer 202 Magnum	659

Modell	Code-No.
Sauer 101	816
Sauer 303	359
Sauer Weatherby	023
Savage 110,116 Kojac	016
Schuler Repetierer	459
Silma Express	809
Steyr Mannlicher SL	017
Steyr SL,L-Jagdmatch	086
Steyr M	086
Steyr L	017
Steyr Classic SBS	202
Steyr Mannlicher SM12	202
Swiss Arms SHR 970	175
TIKKA 55,65	038
TIKKA 558,590,658,690	138
TIKKA T3	038
Verney Carron, Auto Impact	811
Verney Carron, Impact plus	405
Voere 2155/2165 Kufstein	021
Voere Titan II	045
Voere 2185 Automat	141
Voere LBW	815
Weatherby-Mark V, 300	023
Winchester 70 Standart	024
Winchester 70 Magnum	029
Winchester 70 Magnum XTR	085
Winchester Mod. SXR Vulkan	003
Zastava Modell 70	049

**Objektivring mit Hakenfuß brüniert!**  
**Lens ring with retro-snap-on foot in gunmetal finish!**  
**Anneau d'objectif avec pied à crochet finition bronzée!**

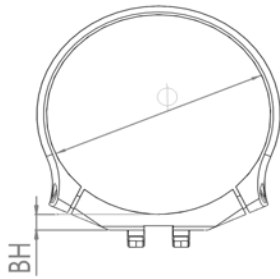

Ø (mm)	BH=4.5mm	BH=7.5mm	
48,00	Z045ZA0548	Z075ZA0548	
50,00	Z045ZA0550	Z075ZA0550	
54,00	Z045ZA0554	Z075ZA0554	
56,00	Z045ZA0556	Z075ZA0556	
57,00	Z045ZA0557	Z075ZA0557	
58,30	Z045ZA0558	Z075ZA0558	
62,00	Z045ZA0562	Z075ZA0562	

Ø (mm)	BH=5.5mm		
48,00	Z055ZA0548		

**Objektivring einseitig geschlitzt mit Hakenfuß, weißfertig!**  
**englisch**  
**français**

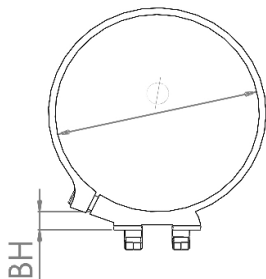

Ø (mm)	BH=4.5mm	BH=7.5mm	
48,00	Z145ZA0548		

**Basis Classic für Hakenfuß, brüniert mit Gravur!**  
**Classic base for retro-snap-on foot with engraving!**  
**Base classique pour pied à crochet, finition bronzée avec gravure!**

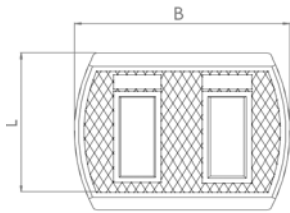

<b>B x L</b>		
<b>27,00 x 21,85</b>	Z218ZG0301	
<b>27,00 x 23,85</b>	Z238ZG0301	

**Basis Classic für Mauser 66, brüniert mit Gravur!**  
**Classic Base for Mauser 66 Model, in engraved gunmetal finish!**  
**Base Classic pour Mauser 66, bronzé avec gravure!**

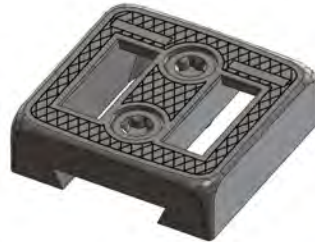
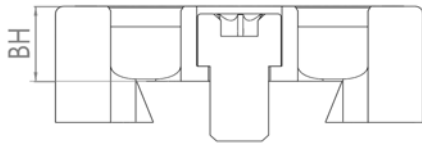

<b>BH (mm)</b>		
<b>5,0 mm</b>	1120Z22009	
<b>7,5 mm</b>	1121Z22009	

**Klemmring mit Support inkl. Schrauben (Torx-Ausführung) für Classic und Contra brüniert!**  
**Clamping Bracket with Mounting Shoe including fixing screws (Torx Version) for the Classic and Contra Models in gunmetal finish!**  
**Collier de serrage avec support et vis (Modèle Torx) pour Classic et Contra finition bronzée!**

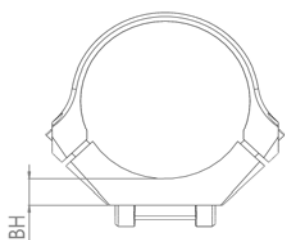

BH*(mm)	Ø 30mm	Ø 1"/26mm	
3,50	Z035ZA0030	Z035ZA0026	
4,00	Z040ZA0030	Z040ZA0026	
4,50	Z045ZA0030	Z045ZA0026	
5,00	Z050ZA0030	Z050ZA0026	
5,50	Z055ZA0030	Z055ZA0026	
6,00	Z060ZA0030	Z060ZA0026	

\*BH-Gesamt: immer in Verbindung mit Schlösschenfüße.

\*Total Mounting Shoe Height: only for connection to catch shoes.

\*Hauteur totale de montage: toujours en association avec les embases à verrou.

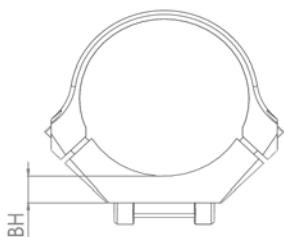

BH*(mm)	Ø 36mm	Ø 34mm	
3,50	Z035ZA0036	Z035ZA0034	
4,00	Z040ZA0036	Z040ZA0034	
4,50	Z045ZA0036	Z045ZA0034	
5,00	Z050ZA0036	Z050ZA0034	
5,50	Z055ZA0036	Z055ZA0034	
6,00	Z060ZA0036	Z060ZA0034	

BH*(mm)	Ø 40mm		
4,00	Z040ZA0040		
4,50	Z045ZA0040		
5,00	Z050ZA0040		
5,50	Z055ZA0040		

\*BH-Gesamt: immer in Verbindung mit Schlösschenfüße.

\*Total Mounting Shoe Height: only for connection to catch shoes.

\*Hauteur totale de montage: toujours en association avec les embases à verrou.

**Support Zeiss 45° für Classic und Contra brüniert!**

**'Zeiss 45°' Mounting Shoe for the Classic and Contra Models in gunmetal finish!**

**Support Zeiss 45° pour Classic et Contra finition bronzée!**

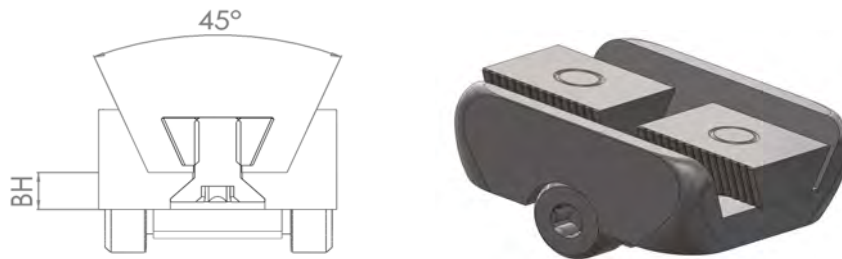

BH*(mm)	Zeiss 45°	
3,50	Z035ZA1245	
4,00	Z040ZA1245	
4,50	Z045ZA1245	
5,00	Z050ZA1245	

\*BH-Gesamt: immer in Verbindung mit Schösschenfüße.

\*Total Mounting Shoe Height: only for connection to catch shoes.

\*Hauteur totale de montage: toujours en association avec les embases à verrou.

**Support Swarovski für Classic und Contra brüniert!**

**Swarovski Mounting Shoe for the Classic and Contra Models in gunmetal finish!**

**Support Swarovski pour Classic et Contra finition bronzée!**

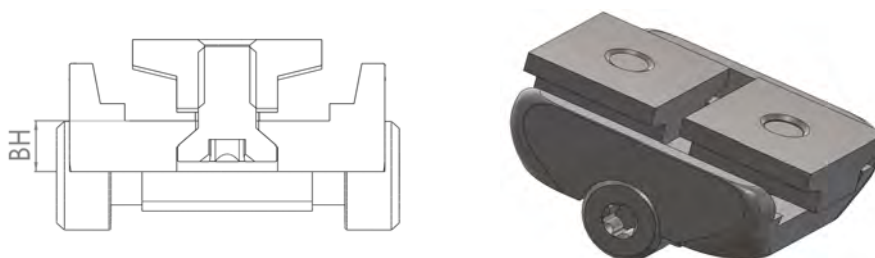

BH*(mm)	Swarovski	
3,50	Z035ZA1860	
4,00	Z040ZA1860	
4,50	Z045ZA1860	
5,00	Z050ZA1860	

\*BH-Gesamt: immer in Verbindung mit Schösschenfüße.

\*Total Mounting Shoe Height: only for connection to catch shoes.

\*Hauteur totale de montage: toujours en association avec les embases à verrou.

**Support Zeiss 70° nur für Classic brüniert!**

**'Zeiss 70°' Mounting Shoe for the Classic Model in gunmetal finish!**

**Support Zeiss 70° uniquement pour Classic finition bronzée!**

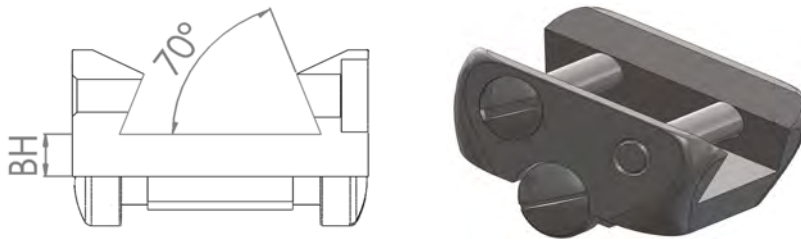

BH*(mm)	Zeiss 70°	
3,50	Z035ZA0840	
4,00	Z040ZA0840	
4,50	Z045ZA0840	
5,00	Z050ZA0840	

\*BH-Gesamt: immer in Verbindung mit Schlösschenfüße.

\*Total Mounting Shoe Height: only for connection to catch shoes.

\*Hauteur totale de montage: toujours en association avec les embases à verrou.

**Support S&B-Convex für Classic und Contra brüniert!**

**S&B-Convex Mounting Shoe for the Classic and Contra Models in gunmetal finish!**

**Support S&B-Convex pour Classic et Contra finition bronzée!**

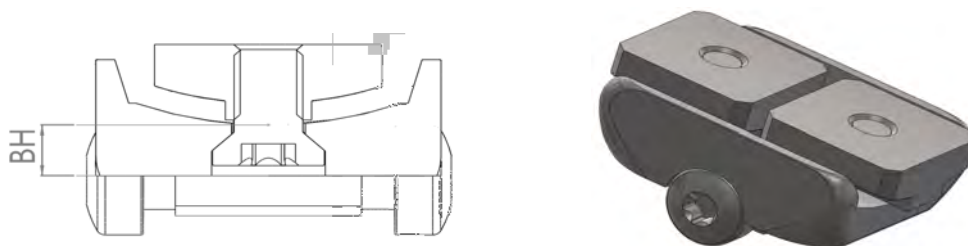

BH*(mm)	S&B	
3,50	Z035ZA3170	
4,00	Z040ZA3170	
4,50	Z045ZA3170	
5,00	Z050ZA3170	

\*BH-Gesamt: immer in Verbindung mit Schlösschenfüße.

\*Total Mounting Shoe Height: only for connection to catch shoes.

\*Hauteur totale de montage: toujours en association avec les embases à verrou.



**Verlängerter Schösschenfuß für Contra brüniert!**  
**Extended Catch Shoe for the Contra Model in gunmetal finish!**  
**Embase à verrou rallongée pour Contra finition bronzée!**



<b>L = (mm)</b>	<b>BH*5,00</b>	
17,00	Z050ZA2617	
26,00	Z050ZA2626	
32,00	Z050ZA2632	

<b>L = (mm)</b>	<b>BH*7,00</b>	
17,00	Z070ZA2617	
26,00	Z070ZA2626	
32,00	Z070ZA2632	

<b>L = (mm)</b>	<b>BH*9,00</b>	
17,00	Z090ZA2617	
26,00	Z090ZA2626	
32,00	Z090ZA2632	

\*BH-Gesamt: immer in Verbindung mit Support.

\*Total Mounting Shoe Height: Mounting supplied with retro-catch shoe in all cases.

\*Hauteur totale de montage: toujours en association avec le support.

**Schlösschenfuß für Classic oder Contra brüniert!**

**Retro-Snap-On Mounting for the Catch Shoe of the Classic or the Contra Models in gunmetal finish!**

**Embase à verrou pour Classic ou Contra finition bronzée!**

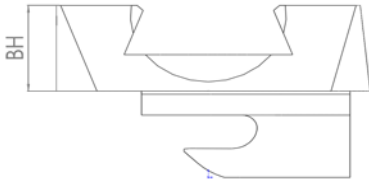

BH*(mm)		
5,00	Z050ZA0635	
7,00	Z070ZA0635	
9,00	Z090ZA0635	
11,00	Z110ZA0635	
13,00	Z130ZA0635	
15,00	Z150ZA0635	
17,00	Z170ZA0635	
19,00	Z190ZA0635	
21,00	Z210ZA0635	
23,00	Z230ZA0635	

\*BH-Gesamt: immer in Verbindung mit Support.

\*Total Mounting Shoe Height: Mounting supplied with retro-catch shoe in all cases.

\*Hauteur totale de montage: toujours en association avec le support.

**Adapter für Leuchtpunktvisier DOCTERsight / Zeiss Compact Point brüniert! Für Classic oder Contra.**

**Adapter for the 'DOCTERsight' light spot sight and the 'Zeiss Compact Point' light spot sight in gunmetal finish. Suitable for the Classic or the Contra Model.**

**Adaptateur pour hausse laser DOCTERsight / Zeiss Compact Point finition bronzée! Pour Classic ou Contra.**

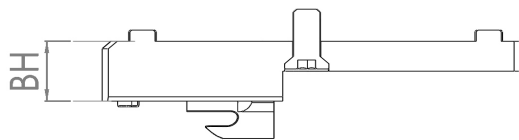

BH*(mm)		
1,50*	Z050ZA1910	
5,00	Z050ZA1908	
8,00**	Z080ZA1908	

\*Nur für Zeiss Compact Point!

\*Only for Zeiss Compact Point!

\*Uniquement pour Zeiss Compact Point!

\*\* Auf Anfrage!

\*\* Supply on request!

\*\*sur demande!

**Adapter für Aimpoint H1 brüniert! Für Classic oder Contra.**

**Adapter for the Aimpoint H1 in gunmetal finish. Suitable for the Classic or the Contra Model.**

**Adaptateur pour Aimpoint H1 finition bronzée! Pour Classic ou Contra.**

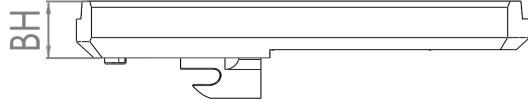

BH*(mm)		
6,00	Z060ZA1911	

\*Weitere BH auf Anfrage!

\*Other Mounting Shoe Heights available upon enquiry.

\*Autres hauteurs de montage sur demande!

Schlösschen Classic graviert, brüniert oder weißfertig!

Catch (scored surfaces) for the Classic Model in gunmetal finish also available in white metal finish!

Verrou Classic gravée, finition bronzée ou finition blanche !



B=18 (22) x L=26	brüniert Gunmetal finish finition bronzée	weißfertig White metal finish finition blanche	
	B= ↓	B= ↓	
BBF54	0126Z 18 801	5126Z 18 801	
Krieghoff DB Drilling (L31)	0131Z18804	0531Z18804	
Krico 600,700, 900,902	0126Z18006		
Mauser K98	0126Z18010	5126Z18010	
Mauser 66	0126Z18009		
Mauser 94,96	0126Z18156		
Merkel DB Drilling (L31)	0131Z18804	0531Z18804	
Remington 700	0126Z22012		
Sauer 202	0131Z18659		
Sauer 80	0131Z18015		

\*Weitere Modelle grundsätzlich auf Anfrage möglich!

\*Additional models also available strictly upon enquiry!

\*Autres modèles en principe possibles sur demande!

Schlösschen Classic mit Prisma außen, graviert und brüniert! Zum einschwalben in Laufschiene.

Catch for the Classic Model with exterior prism; scored surfaces and in gunmetal finish; for simple dovetailing action into the runner.

Verrou Classic avec prisme extérieur, gravé et finition bronzée! Pour assemblage dans la bande.

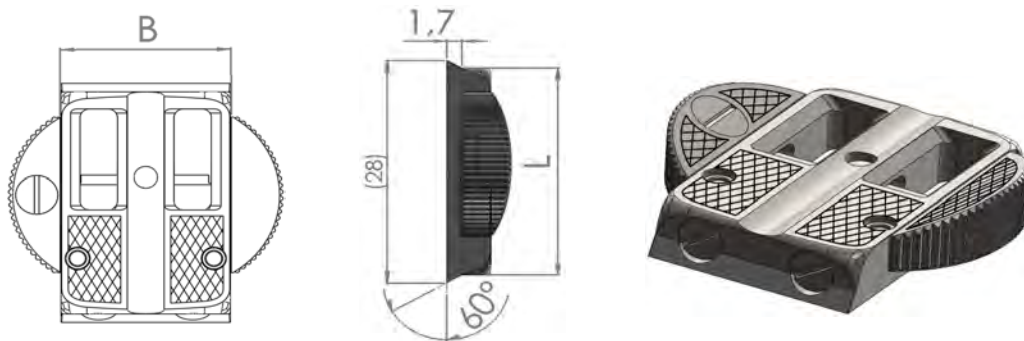

<b>B x L</b>	BH=5mm Height =5mm HM=5mm	
<b>18,00x26,00</b>	Z018ZA0665	

Schlösschen Classic mit Prisma innenliegend, graviert und brüniert! Zum einschwalben auf halb abgefrästes altes Schlösschen.

Catch for the Classic Model with interior prism; scored surfaces and in gunmetal finish; for a simple dovetailing into the semi-ground-off previous catch.

Verrou Classic avec prisme intérieur, gravé et finition bronzée ! Pour assemblage dans l'ancien verrou à moitié fraisé.

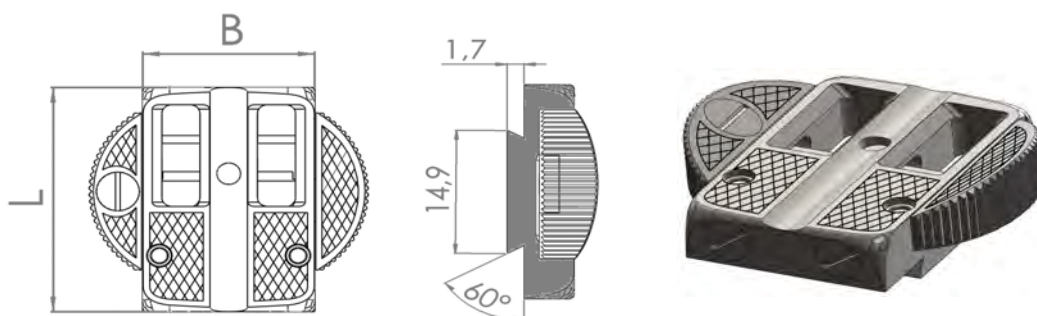

<b>B x L</b>	BH=5mm Height =5mm HM=5mm	
<b>18,00x26,00</b>	Z018ZA0666	

**Schlösschen Classic (18mm/22mm) weißfertig ohne Gravur!**  
**Catch for the Classic Model (18mm/22mm) in white metal finish without scored surface!**  
**Verrou Classic (18mm/22mm) finition blanche sans gravure!**

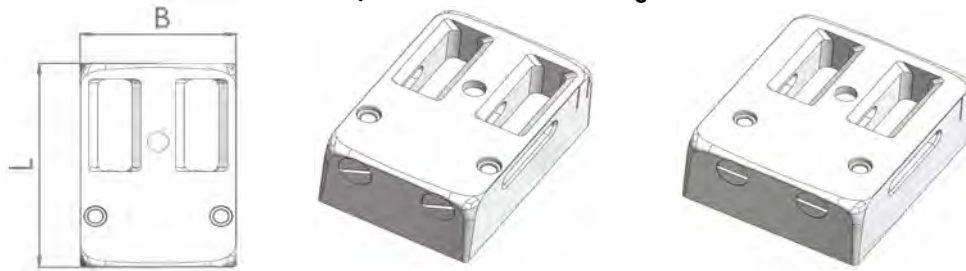

<b>B x L</b>	BH=10mm Height =10mm HM=10mm	
<b>18,00x26,00</b>	Z018ZA0326	
<b>18,00x31,00</b>	Z018ZA0331	
<b>22,00x26,00</b>	Z022ZA0326	
<b>22,00x31,00</b>	Z022ZA0331	

**Schieber Ausführung \*Classic\* weißfertig ohne Gravur!**  
**Classic Model Version Slide in white metal finish without scored surface!**  
**Modèle de coulisse «Classic» finition blanche sans gravure!**

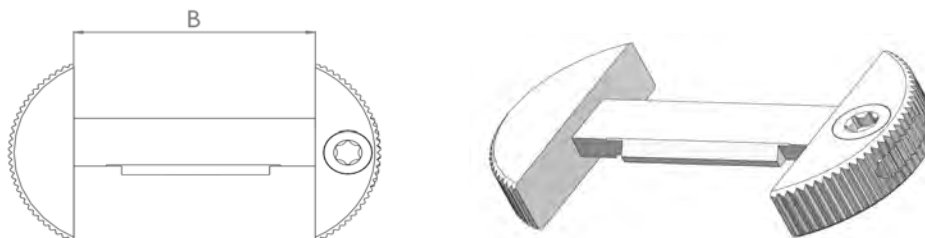

<b>B=mm</b>		
<b>18,00</b>	Z018ZA0604	
<b>22,00</b>	Z022ZA0604	

Schieber Ausführung \*Bockbüchse\* weißfertig ohne Gravur!  
 'Bockbuechse' Heavy Calibre Hunting Rifle - Slide Version in white metal finish without scored surfaces!

Modèle de coulisse «carabine express» finition blanche sans gravure!

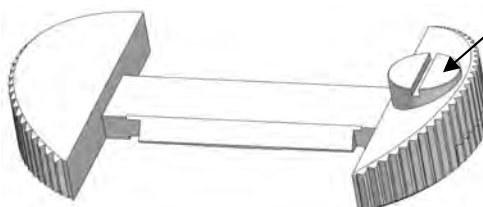
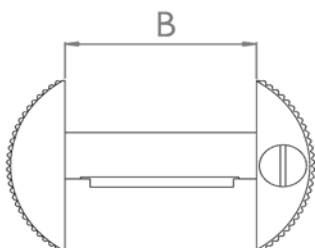

Schraube zum anpassen!  
 Adjusting screw!  
 Vis à régler!

<b>B=mm</b>		
<b>18,00</b>	Z018ZA0667	

Schieber Ausführung \*Drilling\* weißfertig ohne Gravur!  
 'Drilling' Three Barrelled Sports Gun – Slide Version in white metal finish without scored surfaces!

Modèle de coulisse «Drilling» finition blanche sans gravure!

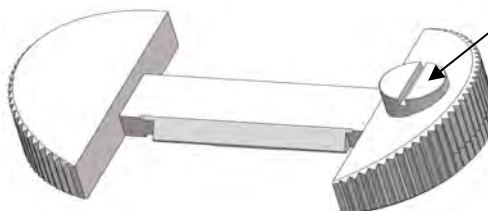
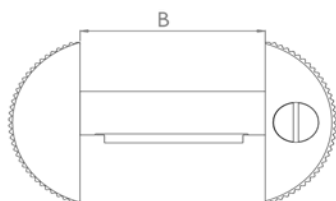

Schraube zum anpassen!  
 Adjusting screw!  
 Vis à régler!

<b>B=mm</b>		
<b>18,00</b>	Z018ZA0630	
<b>22,00</b>	Z022ZA0630	

Schieber Ausführung \*Contra\* brüniert ohne Gravur!  
 Contra Model Version Slide in gunmetal finish without scored surfaces!  
 Modèle de coulisse «Contra» finition bronzée sans gravure!

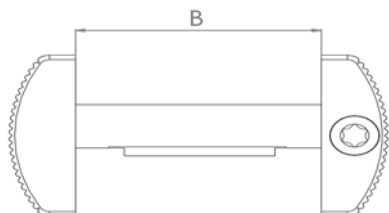

<b>B=mm</b>		
<b>18,00</b>	Z018ZA0650	
<b>22,00</b>	Z022ZA0650	

**Hakenfuß mit Ring für Classic und Contra brüniert!****Retro-Snap-on Mounting Shoe with bracket for the Classic and Contra Models in gunmetal finish!****Pied à crochet avec collier pour Classic et Contra finition bronzée!**

BH (mm)	Ø 30mm	1"/Ø 26mm	
11,00*	Z110ZA1330	Z110ZA1326	
12,00*	Z120ZA1330	Z120ZA1326	
13,00*	Z130ZA1330	Z130ZA1326	
13,50*	Z135ZA1330	Z135ZA1326	
14,00*	Z140ZA1330	Z140ZA1326	
15,00*	Z150ZA1330	Z150ZA1326	
16,00*	Z160ZA1330	Z160ZA1326	
17,00*	Z170ZA1330	Z170ZA1326	
18,00*	Z180ZA1330	Z180ZA1326	
19,00*	Z190ZA1330	Z190ZA1326	

\*Nicht in Verbindung mit Contra Basis Artikelnummer 12xxZxxxxx möglich!

\*Not possible in conjunction with the Contra Base Article Number 12xxZxxxx!

\*Indisponible avec Contra Basis numéro d'article 12xxZxxxxx!

**Hakenfuß mit Ring für Contra brüniert!****Retro-Snap-on Mounting Shoe with bracket for the Contra Models in gunmetal finish!****Pied à crochet avec collier pour Contra finition bronzée!**

BH (mm)	Ø 30mm	1"/Ø 26mm	
9,00*	Z090ZA3330	Z090ZA3326	
10,00*	Z100ZA3330	Z100ZA3326	
11,00*	Z110ZA3330	Z110ZA3326	
13,00*	Z130ZA3330	Z130ZA3326	
17,00*	Z170ZA3330		

\*Nur in Verbindung mit Contra Basis Artikelnummer 12xxZxxxxx möglich!

\*Only possible in conjunction with the Contra Base Art. No.: 12xxZxxxx!

\*Uniquement disponible avec Contra Basis numéro d'article 12xxZxxxxx!



**Hakenfuß mit Ring für Classic und Contra brüniert!****Retro-Snap-on Mounting Shoe with bracket for the Classic and Contra Models in gunmetal finish!****Pied à crochet avec collier pour Classic et Contra finition bronzée!**

BH (mm)	Ø 36mm	Ø 34mm	
11,00*	Z110ZA1336	Z110ZA1334	
12,00*	Z120ZA1336	Z120ZA1334	
13,00*	Z130ZA1336	Z130ZA1334	
14,00*	Z140ZA1336	Z140ZA1334	
15,00*	Z150ZA1336	Z150ZA1334	

\*Nicht in Verbindung mit Contra Basis Artikelnummer 12xxZxxxxx möglich!

\*Not possible in conjunction with the Contra Base Article Number 12xxZxxxx!

\*Indisponible avec Contra Basis numéro d'article 12xxZxxxxx!

**Hakenfuß mit Ring für Contra brüniert!****Retro-Snap-on Mounting Shoe with bracket for the Contra Models in gunmetal finish!****Pied à crochet avec collier pour Contra finition bronzée!**

BH (mm)	Ø 36mm	Ø 34mm	
9,00*	Z090ZA3336	Z090ZA3334	
10,00*	Z100ZA3336	Z100ZA3334	
11,00*	Z110ZA3336	Z110ZA3334	
12,00*	Z120ZA3336	Z120ZA3334	
13,00*	Z130ZA3336	Z130ZA3334	

\*Nur in Verbindung mit Contra Basis Artikelnummer 12xxZxxxxx möglich!

\*Only possible in conjunction with the Contra Base Art. No.: 12xxZxxxx!

\*Uniquement disponible avec Contra Basis numéro d'article 12xxZxxxxx!

**Hakenfuß mit Ring für Classic und Contra brüniert!****Retro-Snap-on Mounting Shoe with bracket for the Classic and Contra Models in gunmetal finish!****Pied à crochet avec collier pour Classic et Contra finition bronzée!**

BH (mm)	Ø 40mm		
11,00*	Z110ZA1340		
12,00*	Z120ZA1340		
13,00*	Z130ZA1340		
14,00*	Z140ZA1340		
15,00*	Z150ZA1340		

\*Nicht in Verbindung mit Contra Basis Artikelnummer 12xxZxxxxx möglich!

\*Not possible in conjunction with the Contra Base Article Number 12xxZxxxx!

\*Indisponible avec Contra Basis numéro d'article 12xxZxxxxx!

**Hakenfuß mit Ring für Contra brüniert!****Retro-Snap-on Mounting Shoe with bracket for the Contra Models in gunmetal finish!****Pied à crochet avec collier pour Contra finition bronzée!**

BH (mm)	Ø 40mm		
9,00*	Z090ZA3340		
10,00*	Z100ZA3340		
11,00*	Z110ZA3340		
12,00*	Z120ZA3340		
13,00*	Z130ZA3340		

\*Nur in Verbindung mit Contra Basis Artikelnummer 12xxZxxxxx möglich!

\*Only possible in conjunction with the Contra Base Art. No.: 12xxZxxxx!

\*Uniquement disponible avec Contra Basis numéro d'article 12xxZxxxxx!

**Hakenfuß Zeiss 45° für Classic und Contra brüniert!****'Zeiss 45°'Retro-Snap-on Mounting Shoe for the Classic and Contra Models in gunmetal finish!****Pied à crochet Zeiss 45° pour Classic et Contra finition bronzée!**

BH(mm)		
11,00*	Z110ZA1245	
12,00*	Z120ZA1245	
13,00*	Z130ZA1245	
14,00*	Z140ZA1245	
15,00*	Z150ZA1245	
16,00*	Z160ZA1245	

\*Nicht in Verbindung mit Contra Basis Artikelnummer 12xxZxxxxx möglich!

\*Not possible in conjunction with the Contra Base Article Number 12xxZxxxx!

\*Indisponible avec Contra Basis numéro d'article 12xxZxxxxx!

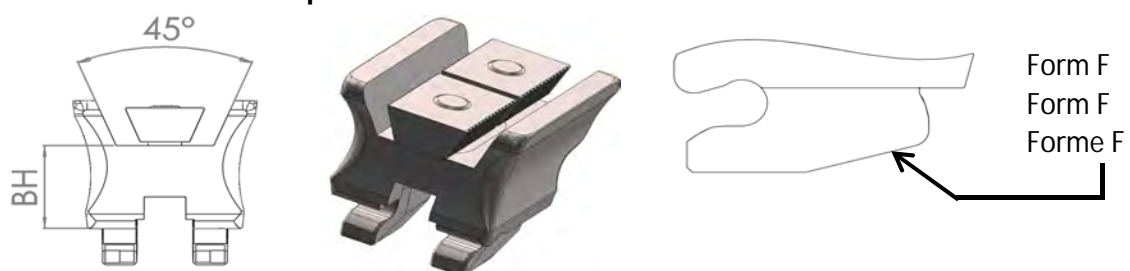
**Hakenfuß Zeiss 45° für Contra brüniert!****'Zeiss 45°'Retro-Snap-on Mounting Shoe for the Contra Models in gunmetal finish!****Pied à crochet Zeiss 45° pour Contra finition bronzée!**

BH(mm)		
9,00*	Z090ZA3245	
10,00*	Z100ZA3245	
11,00*	Z110ZA3245	
13,00*	Z130ZA3245	

\*Nur in Verbindung mit Contra Basis Artikelnummer 12xxZxxxxx möglich!

\*Only possible in conjunction with the Contra Base Art. No.: 12xxZxxxx!

\*Uniquement disponible avec Contra Basis numéro d'article 12xxZxxxxx!

**Hakenfuß Swarovski für Classic und Contra brüniert!****'Swarovski' Retro-Snap-on Mounting Shoe for the Classic and Contra Models in gunmetal finish!****Pied à crochet Swarovski pour Classic et Contra finition bronzée!**

BH(mm)		
11,00*	Z110ZA1860	
12,00*	Z120ZA1860	
13,00*	Z130ZA1860	
14,00*	Z140ZA1860	
15,00*	Z150ZA1860	
16,00*	Z160ZA1860	

\*Nicht in Verbindung mit Contra Basis Artikelnummer 12xxZxxxxx möglich!

\*Not possible in conjunction with the Contra Base Article Number 12xxZxxxx!

\*Indisponible avec Contra Basis numéro d'article 12xxZxxxx!

**Hakenfuß Swarovski für Contra brüniert!****'Swarovski' Retro-Snap-on Mounting Shoe for the Contra Models in gunmetal finish!****Pied à crochet Swarovski pour Contra finition bronzée!**

BH(mm)		
9,00*	Z090ZA3260	
10,00*	Z100ZA3260	
11,00*	Z110ZA3260	
13,00*	Z130ZA3260	

\*Nur in Verbindung mit Contra Basis Artikelnummer 12xxZxxxxx möglich!

\*Only possible in conjunction with the Contra Base Art. No.: 12xxZxxxx!

\*Uniquement disponible avec Contra Basis numéro d'article 12xxZxxxx!

**Hakenfuß S&B-Convex für Classic und Contra brüniert!****'S&B-Convex' Retro-Snap-on Mounting Shoe for the Classic and Contra Models in gunmetal finish!****Pied à crochet S&B-Convex pour Classic et Contra finition bronzée!**

BH(mm)		
11,00*	Z110ZA3170	
12,00*	Z120ZA3170	
13,00*	Z130ZA3170	
14,00*	Z140ZA3170	
15,00*	Z150ZA3170	
16,00*	Z160ZA3170	

\*Nicht in Verbindung mit Contra Basis Artikelnummer 12xxZxxxxx möglich! Form F auf Anfrage möglich.

\*Not possible in conjunction with the Contra Base Art. No.: 12xxZxxxx! Form F possible upon request.

\*Indisponible avec Contra Basis numéro d'article 12xxZxxxxx! Forme F disponible sur demande.

**Hakenfuß S&B-Convex für Contra brüniert!****'S&B-Convex' Retro-Snap-on Mounting Shoe for the Contra Models in gunmetal finish!****Pied à crochet S&B-Convex pour Contra finition bronzée!**

BH(mm)		
9,00*	Z090ZA3270	
10,00*	Z100ZA3270	
11,00*	Z110ZA3270	
13,00*	Z130ZA3270	

\*Nur in Verbindung mit Contra Basis Artikelnummer 12xxZxxxxx möglich!

\*Only possible in conjunction with the Contra Base Art. No.: 12xxZxxxx!

\*Uniquement disponible avec Contra Basis numéro d'article 12xxZxxxxx!

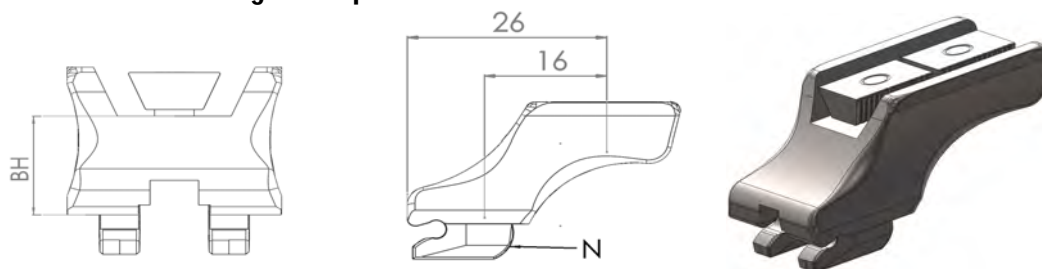
**Verlängerter Hakenfuß Zeiss für Classic und Contra brüniert!****'Zeiss' Retro-Snap-on extended Mounting Shoe for the Classic and Contra Models in gunmetal finish!****Pied à crochet rallongé Zeiss pour Classic et Contra finition bronzée!**

BH(mm)	Kraglänge =16mm Cantilever Length 16mm Longueur de la partie en saillie 16mm	
11,00*	Z110ZA1645	
12,00*	Z120ZA1645	
13,00*	Z130ZA1645	
14,00*	Z140ZA1645	
15,00*	Z150ZA1645	
16,00*	Z160ZA1645	

\*Nicht in Verbindung mit Contra Basis Artikelnummer 12xxZxxxxx möglich! Form F auf Anfrage möglich.

\*Not possible in conjunction with the Contra Basie Art. No.: 12xxZxxxx! Form F possible upon request.

\*Indisponible avec Contra Basis numéro d'article 12xxZxxxxx! Forme F disponible sur demande.

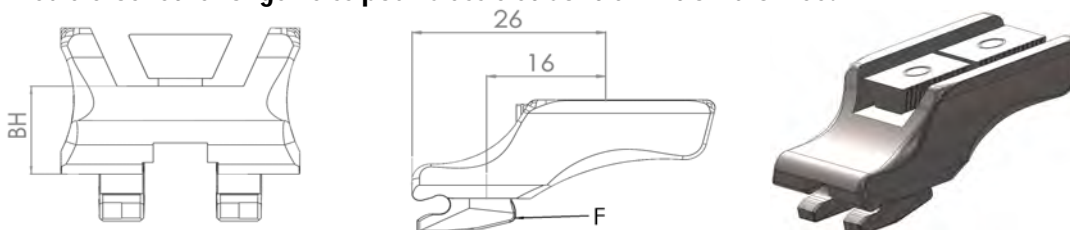
**Verlängerter Hakenfuß Zeiss für Classic und Contra brüniert!****'Zeiss' Retro-Snap-on extended Mounting Shoe for the Classic and Contra Models in gunmetal finish!****Pied à crochet rallongé Zeiss pour Classic et Contra finition bronzée!**

BH(mm)	Kraglänge =16mm Cantilever Length 16mm Longueur de la partie en saillie 16mm	
9,00*	Z090ZA4145	
10,00*	Z100ZA4145	
11,00*	Z110ZA4145	
13,00*	Z130ZA4145	

\*Nur in Verbindung mit Contra Basis Artikelnummer 12xxZxxxxx möglich!

\*Only possible in conjunction with the Contra Base Art. No.: 12xxZxxxx!

\*Uniquement disponible avec Contra Basis numéro d'article 12xxZxxxxx!

**Verlängerter Hakenfuß Swarovski für Classic und Contra brüniert!**  
**'Swarovski' Retro-Snap-on Mounting extended Mounting Shoe for the Classic and Contra Models in gunmetal finish!**

**Pied à crochet rallongé Swarovski pour Classic et Contra finition bronzée!**

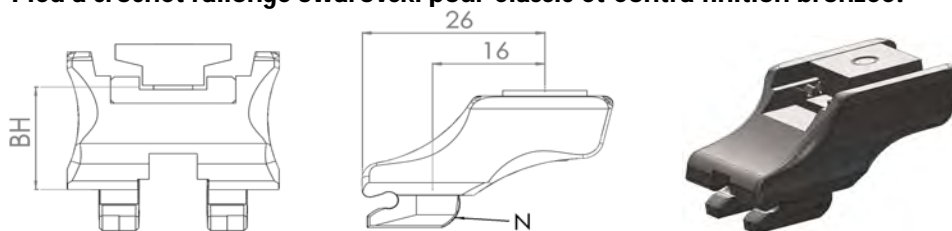

BH(mm)	Kraglänge =16mm Cantilever Length 16mm Longueur de la partie en saillie 16mm	
11,00*	Z110ZA1660	
12,00*	Z120ZA1660	
13,00*	Z130ZA1660	
14,00*	Z140ZA1660	
15,00*	Z150ZA1660	
16,00*	Z160ZA1660	

\*Nicht in Verbindung mit Contra Basis Artikelnummer 12xxZxxxxx möglich! Form F auf Anfrage möglich.

\*Not possible in conjunction with the Contra Base Art. No.: 12xxZxxxx! Form F possible upon request.

\*Indisponible avec Contra Basis numéro d'article 12xxZxxxxx! Forme F disponible sur demande.

**Verlängerter Hakenfuß Swarovski für Classic und Contra brüniert!**  
**'Swarovski' Retro-Snap-on Mounting extended Mounting Shoe for the Classic and Contra Models in gunmetal finish!**

**Pied à crochet rallongé Swarovski pour Classic et Contra finition bronzée!**

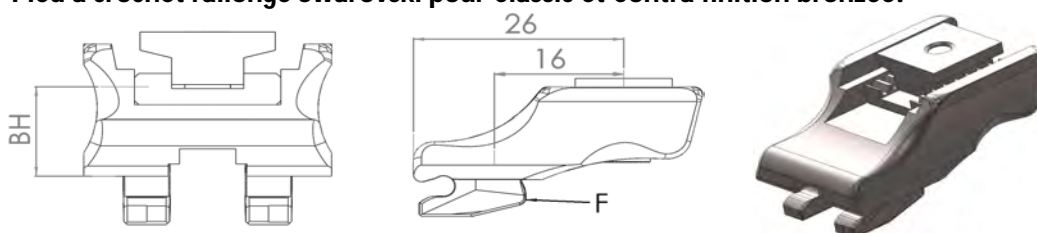

BH(mm)	Kraglänge =16mm Cantilever Length 16mm Longueur de la partie en saillie 16mm	
9,00*	Z090ZA4160	
10,00*	Z100ZA4160	
11,00*	Z110ZA4160	
13,00*	Z130ZA4160	

\*Nur in Verbindung mit Contra Basis Artikelnummer 12xxZxxxxx möglich!

\*Only possible in conjunction with the Contra Base Art. No.: 12xxZxxxx!

\*Uniquement disponible avec Contra Basis numéro d'article 12xxZxxxxx!

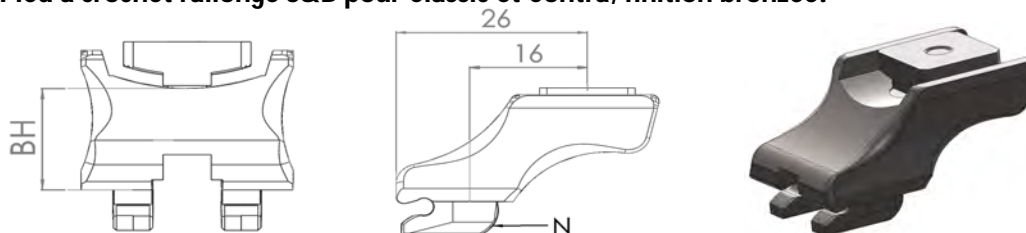
**Verlängerter Hakenfuß S&B für Classic und Contra, brüniert!****'S&B' Retro-Snap-on Mounting Shoe extended Mounting Shoe for the Classic and Contra Models in gunmetal finish!****Pied à crochet rallongé S&B pour Classic et Contra, finition bronzée!**

BH(mm)	Kraglänge =16mm Cantilever Length 16mm Longueur de la partie en saillie 16mm	
11,00*	Z110ZA1670	
12,00*	Z120ZA1670	
13,00*	Z130ZA1670	
14,00*	Z140ZA1670	
15,00*	Z150ZA1670	

\*Nicht in Verbindung mit Contra Basis Artikelnummer 12xxZxxxxx möglich! Form F auf Anfrage möglich.

\*Not possible in conjunction with the Contra Base Art. No.: 12xxZxxxx! Form F possible upon request.

\*Indisponible avec Contra Basis numéro d'article 12xxZxxxxx! Forme F disponible sur demande.

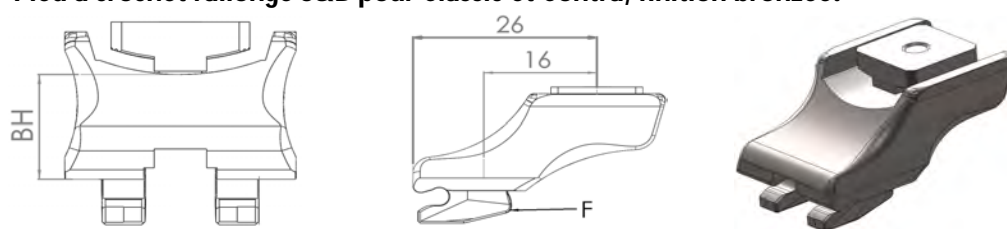
**Verlängerter Hakenfuß S&B für Classic und Contra, brüniert!****'S&B' Retro-Snap-on Mounting Shoe extended Mounting Shoe for the Classic and Contra Models in gunmetal finish!****Pied à crochet rallongé S&B pour Classic et Contra, finition bronzée!**

BH(mm)	Kraglänge =16mm Cantilever Length 16mm Longueur de la partie en saillie 16mm	
9,00*	Z090ZA4170	
10,00*	Z100ZA4170	
11,00*	Z110ZA4170	
13,00*	Z130ZA4170	

\*Nur in Verbindung mit Contra Basis Artikelnummer 12xxZxxxxx möglich!

\*Only possible in conjunction with the Contra Base Art. No.: 12xxZxxxx!

\*Uniquement disponible avec Contra Basis numéro d'article 12xxZxxxxx!



**Basis Contra brüniert!**  
**Contra Base in gunmetal finish!**  
**Basis Contra finition bronzée!**

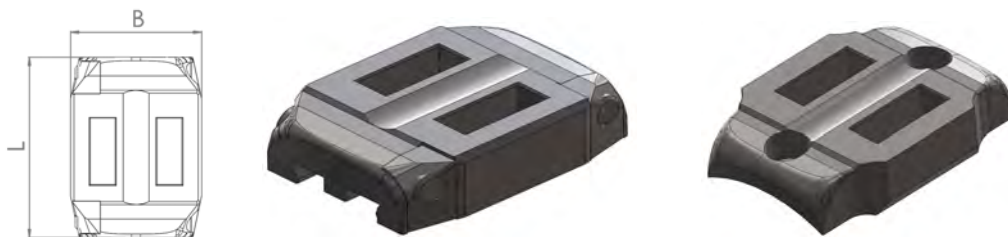

<b>B=22 x L=30</b> BH=5mmHeight =5mmHM=5mm	<b>B =</b> ↓	
*Anschütz Rep. 1780	1230Z22802	
*Anschütz (11mm Schiene)	1230Z22803	
Antonio Zoli-Zoli 1900	1130Z22305	
*Benelli Argo	1230Z22273	
*Brügger CZ	1225Z22812	
*Carl Gustav-2000	1230Z22194	
*Carl Gustav-3000	1230Z22194	
*Carl Gustav-4000	1230Z22459	
*Chapuis Express	1225Z20810	
*FN Browning-A-Bolt,Eurobolt	1230Z22202	
*FN Browning BARI,BARII, CBL,ACERA,BLR,CLR	1230Z22003	
FN Browning-Browning Mauser	1130Z22004	
*FN Browning-European	1230Z22143	
FN Browning X-Bolt	1130Z22212	
*Haenel SLB 2000	1230Z22187	
Haenel Jaeger 10	1130Z22806	
*Heckler & Koch SLB2000	1230Z22187	

Heym SR20	1130Z22060	
*Heym SR40	<b>1230Z22108</b>	
Heym SR30	1130Z22206	
Heym SR21	1130Z22306	
*Krieghoff DB Drilling	<b>1231Z20804</b>	
Krico 700,900,902	1130Z22006	
Krico 600	1130Z22006	
Mauser K98	1130Z22010	
Mauser M12	1130Z22819	
Mauser 94,96 Nr.<96011999	1130Z22156	
Mauser 94,96 Nr.>96012000	1130Z22256	
*Merkel Helix	<b>1230Z27808</b>	
*Merkel SR1, Automatic	<b>1230Z22186</b>	
*Merkel DB Drilling	<b>1231Z20804</b>	
Remington 700	1130Z22012	
*Remington 7400, 7600	<b>1230Z22074</b>	
*RWS/Rössler, Titan 6	<b>1230Z22459</b>	
RWS/Rössler, Titan 16	1130Z22814	
Sabatti Rover	1130Z22023	
*Sako Finnwolf	<b>1230Z22070</b>	
*Sako Vixen L461	<b>1230Z22214</b>	
*Sako Forester L579	<b>1230Z22214</b>	

*Sako Finnbear L61R	1230Z22214	
*Sako 85	1230Z22214	
*Sauer 80,90,92	1230Z22015	
*Sauer 200	1230Z22059	
Sauer 202 Medium System	1130Z22659	
Sauer 202 Magnum System	1130Z22659	
Sauer 101	1130Z22816	
*Sauer 303	1230Z22359	
Sauer Weatherby	1130Z22023	
Savage 110, 116 Kojac	1130Z22016	
*Schuler Repetierer	1230Z22459	
*Silma Express	1225Z20809	
*Steyr Mannlicher SL	1230Z22017	
*Steyr SL, L-Jagdmatch	1230Z22086	
*Steyr M	1230Z22086	
*Steyr L	1230Z22017	
*Steyr Classic SBS	1230Z22202	
*Steyr Mannlicher SM12	1230Z22202	
*Swiss Arms SHR 970	1230Z22175	
*TIKKA 55,65	1230Z22038	
*TIKKA 558,590,658,690	1230Z22138	
*TIKKA T3	1230Z22038	

*Verney Carron, Auto Impact	1230Z22811	
Verney Carron, Impact Plus Impact NT ONE	1130Z22405	
Voere 2155/2165 Kufstein	1130Z22021	
Voere Titan II	1130Z22045	
*Voere 2185 Automat	1230Z22141	
*Voere LBW	1230Z22815	
*Voere Tirolerin	1224Z20817	
Weatherby-Mark V,300	1130Z22023	
Winchester 70 Standart	1130Z22024	
Winchester 70 Magnum	1130Z22029	
Winchester 70 Magnum XTR	1130Z22085	
*Winchester Mod.SXR Vulkan	1230Z22003	
Zastava Modell 70	1130Z22049	

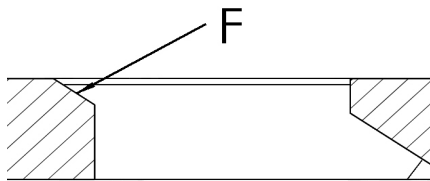
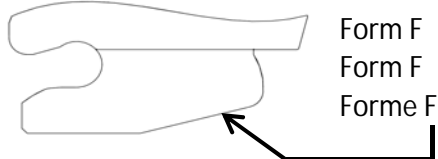

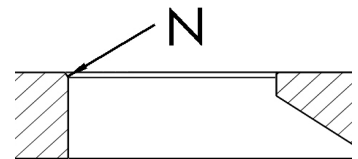
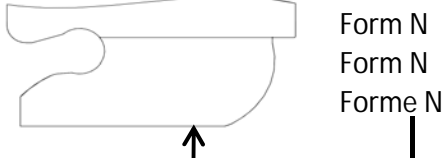

\*Basis mit Art.Nr. 12xxZxxxxx nur in Verbindung mit Hakenfuß Art.Nr. ZxxxZA 3(4) xxx!  
 \*Base with Contra Basis Art. No.: 12xxZxxxx only available in conjunction with retro-snap-on foot Art.No. ZxxxZA3(4)xxx!  
 \*Base avec art. n°12xxZxxxxx uniquement disponible avec pied à crochet art. n° ZxxxZA3(4)xxx!

Basis mit Art.Nr. 11xxZxxxxx nur in Verbindung mit Hakenfuß Art.Nr. ZxxxZA 1 xxx!  
 Base with Art. No.: 11xxZxxxxx only available in conjunction with retro-snap-on foot Art.No.: ZxxxZA1xxx!  
 Base avec art. n° 11xxZxxxxx uniquement disponible avec pied à crochet art. n° ZxxxZA1xxx!

**Basis Contra weißfertig!**  
**Contra Base in white metal finish!**  
**Embase Contra finition blanche!**

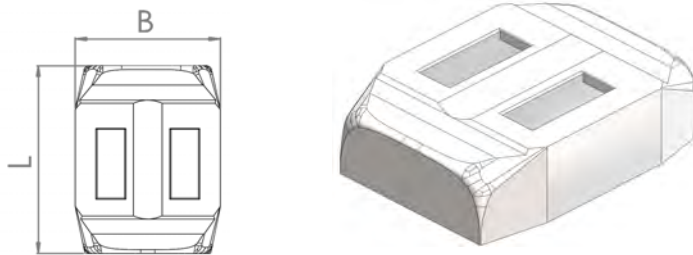

B x L	BH=10mm Height =10mm HM=10mm	
22,00x30,00 Form N	Z022ZA1330	
22,00x30,00 Form F	Z022ZA1334	

**Basis Contra Form F, für Umbau Kipplaufwaffen!**  
**Basis Contra Form F, for "Drillings" and combination guns!**  
**Base pour montage Contra forme F, pour carabine basculante "kipplauf"!**

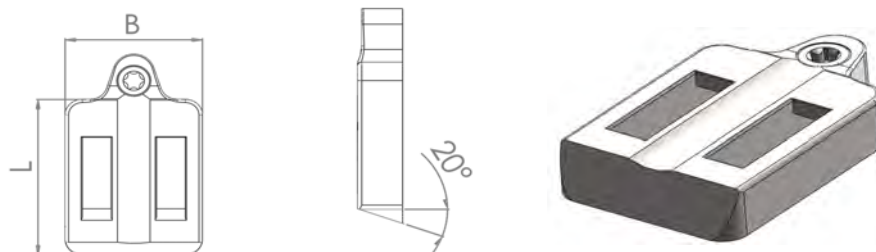

B x L	BH=5mm Height =5mm HM=5mm	
20,00x25,00*	Z020ZA1343	

- \*Ohne Gravur!
- \*Without engraving!
- \*Sans gravure!

**Basis Contra Form F mit Prisma außen, graviert und brüniert! Zum einschwalben in Laufschiene.**

**Basis Contra Form F with exterior prism, engraved and with gunmetal finish, for dovetailing into the running rail!**

**Embase Contra forme F avec prisme extérieur, finition gravée et bronzée! Pour insertion sur la bande de visée!**

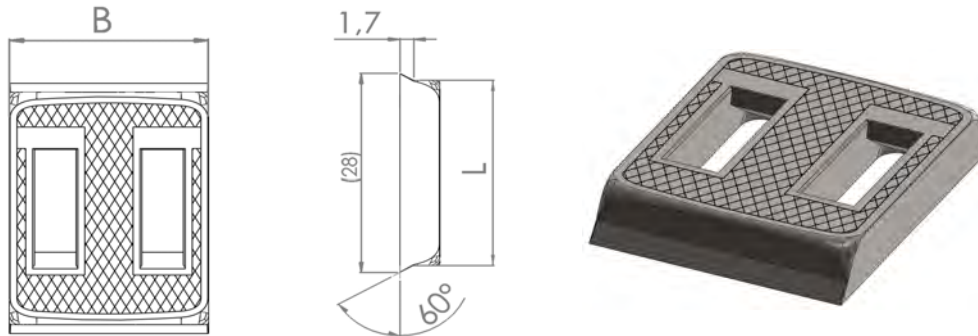

B x L	BH=5mm Height =5mm HM=5mm	
20,00x26,00	Z020ZA1340	
20,00x26,00*	Z020ZW1340	

\*Ohne Gravur!

\*Without engraving!

\*Sans gravure!

**Basis Contra Form F mit Prisma innenliegend, graviert und brüniert! Zum einschwalben in Laufschiene.**

**Basis Contra Form F with interior prism, engraved and with gunmetal finish, for dovetailing into the running rail.**

**Embase Contra forme F avec prisme intérieur, finition gravée et bronzée! Pour insertion sur la bande de visée!**

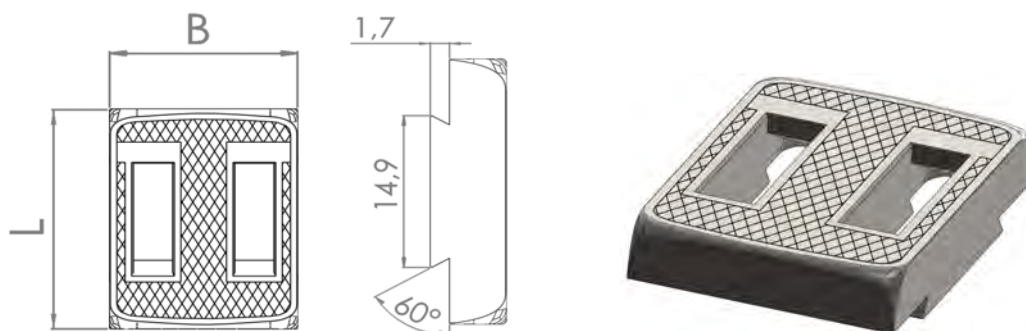

B x L	BH=5mm Height =5mm HM=5mm	
20,00x26,00	Z020ZA1341	
20,00x26,00*	Z020ZW1341	

\*Ohne Gravur!

\*Without engraving!

\*Sans gravure!

Schlösschen Contra (18mm/22mm) brüniert!  
 Contra Catch Base (18mm/22mm) in gunmetal finish!  
 Verrou Contra (18mm/22mm) finition bronzée!

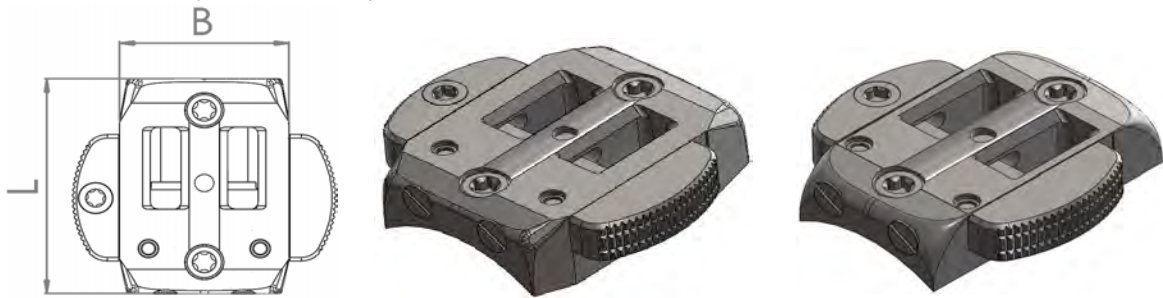

<b>B=18(22) x L=31</b> BH=5mm Height =5mm HM=5mm	<b>B =</b> ↓	
Anschütz Rep. 1780	1131Z 18 802	
Anschütz (11mm Schiene)	1137Z18803	
Antonio Zoli-Zoli 1900	1131Z22305	
Benelli Argo	1131Z18273	
Brüner CZ	1126Z22812	
Carl Gustav-2000	1131Z18194	
Carl Gustav-3000	1131Z18194	
Carl Gustav-4000	1131Z18459	
Chapuis Express	1134Z18810	
FN Browning-A-Bolt,Eurobolt	1131Z18202	
FN Browning BARI,BARII, CBL,ACERA,BLR,CLR	1131Z18003	
FN Browning-European	1131Z18143	
FN Browning-Browning Mauser	1131Z18004	
FN Browning X-Bolt	1131Z22212	
Haenel SLB 2000	1131Z18187	

Haenel Jaeger 10	1131Z18806	
Heckler & Koch SLB2000	1131Z18187	
Heym SR20	1131Z22060	
Heym SR40	1131Z22108	
Heym SR30	1131Z22206	
Heym SR21	1131Z22206	
Krieghoff DB Drilling	Z018ZA0324	
Krico 700,900,902	1131Z22006	
Krico 600	1131Z22006	
Mauser K98	1131Z22010	
Mauser M12	1131Z22819	
Mauser 94,96 Nr.<96011999	1131Z22156	
Mauser 94,96 Nr.>96012000	1131Z22256	
Merkel Helix	1137Z27808	
Merkel SR1, Automatic	1131Z18186	
Merkel DB Drilling	Z018ZA0324	
Remington 700	1131Z22012	
Remington 7400, 7600	1131Z18074	
RWS/Rössler, Titan 6	1131Z22459	
RWS/Rössler, Titan 16	1131Z18814	
Sabatti Rover	1131Z22023	
Sako Finnwolf	1131Z22070	



Sako Vixen L461	1131Z22214	
Sako Forester L579	1131Z22214	
Sako Finnbear L61R	1131Z22214	
Sako 85	1131Z22214	
Sauer 80,90,92	1131Z18015	
Sauer 200	1131Z18059	
Sauer 202 Medium System	1131Z18659	
Sauer 202Magnum System	1131Z18659	
Sauer 101	1131Z22012	
Sauer 303	1137Z22359	
Sauer Weatherby	1131Z22023	
Savage 110, 116 Kojac	1131Z22016	
Schuler Repetierer	1131Z22459	
Silma Express	1134Z18809	
Steyr Mannlicher SL	1131Z18017	
Steyr SL, L-Jagdmatch	1131Z18086	
Steyr M	1131Z18086	
Steyr L	1131Z18017	
Steyr Classic SBS	1131Z18202	
Steyr Mannlicher SM12	1131Z18202	
Swiss Arms SHR 970	1131Z22175	
TIKKA 55,65	1131Z22038	

TIKKA 558,590,658,690	1131Z22138	
TIKKA T3	1131Z22038	
Verney Carron, Auto Impact	1131Z18811	
Verney Carron, Impact Plus Impact NT ONE	1131Z18405	
Voere 2165 Kufstein	1131Z22021	
Voere Titan II	1131Z22045	
Voere 2185 Automat	1131Z18141	
Voere LBW	1136Z18815	
Voere Tirolerin	1136Z18817	
Weatherby-Mark V,300	1131Z22023	
Winchester 70 Standart	1131Z22024	
Winchester 70 Magnum	1131Z22029	
Winchester 70 Magnum XTR	1131Z22085	
Winchester Mod.SXR Vulkan	1131Z18003	
Zastava Modell 70	1131Z22049	

Schlösschen Contra (18mm/22mm) weißfertig!  
 Contra Catch Base (18mm/22mm) in white metal finish!  
 Verrou Contra (18mm/22mm) finition blanche!

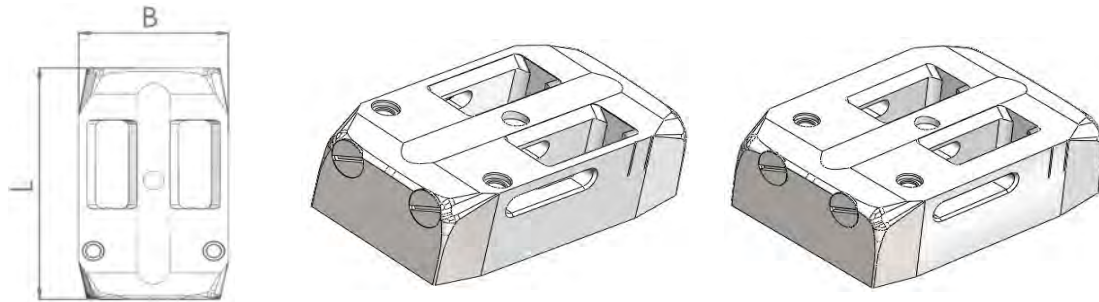

B x L	BH=10mm Height =10mm HM=10mm	
18,00 x 31,00	Z018ZA0631	
22,00 x 31,00	Z022ZA0631	

Schlösschen Contra mit Prisma außen, graviert und brüniert! Zum einschwalben in  
 Laufschiene.

Catch for the Contra Model with exterior prism; scored surfaces and in gunmetal finish; for  
 simple dovetailing action into the runner.

Verrou Contra avec prisme extérieur, gravé et finition bronzée! Pour assemblage dans la  
 bande.

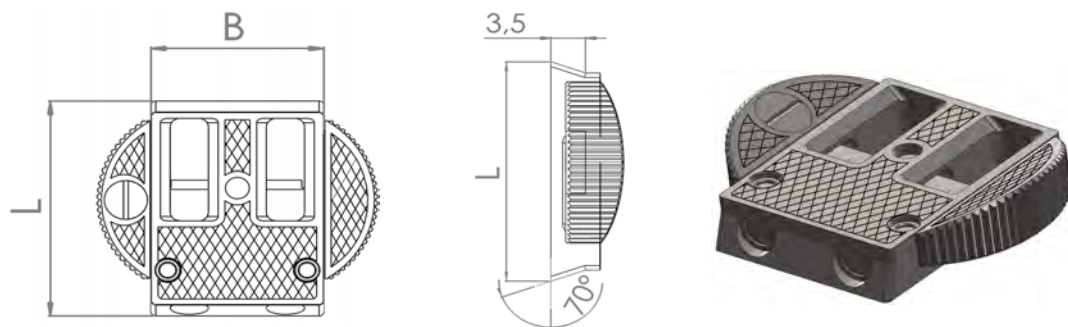

B x L	BH=5mm Height =5mm HM=5mm	
18,00x24,80	Z018ZG0324	
18,00x24,80*	Z018ZA0324	

\*Ohne Gravur!

\*Without engraving!

\*Sans gravure!

**Basis Contra Mauser K98 Form N, weißfertig!**

englisch

français

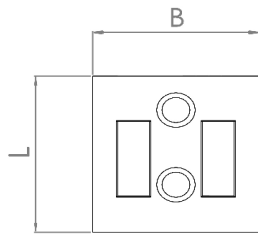

<b>B x L</b>		
22,00 x 23,00	Z000ZB2406	

**Basis Contra Mauser K98 Form F, weißfertig!**

englisch

français

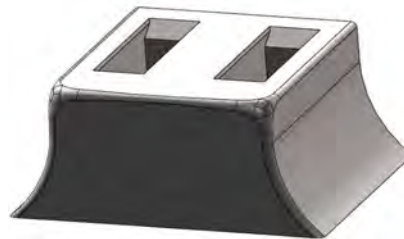
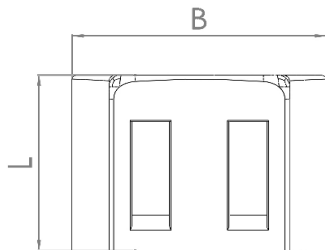

<b>B x L</b>	BH=13mm Height =13mm HM=13mm	
28,00 x 21,50*	Z000ZB2407	
28,00 x 20,00	Z000ZB2405	

**Basis Contra Mauser K98 Form F, weißfertig!**

englisch

français

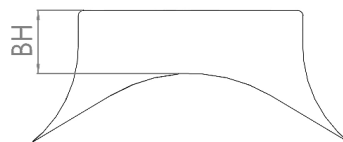
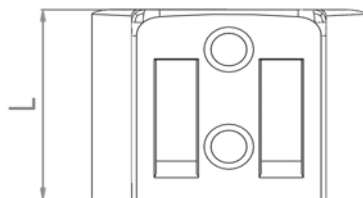

<b>BH x L</b>		
6,50 x 20,00	Z000ZB2402	
5,00 x 20,00	Z000ZB2403	
6,00 x 21,50	Z000ZB2408	

**Basis Rohling Form F, weißfertig!**

englisch

français

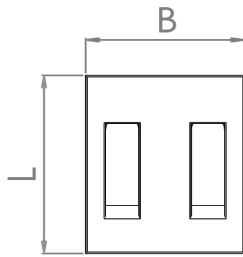

<b>B x L</b>	BH=10mm Height =10mm HM=10mm	
<b>20,00 x 26,00</b>	Z020ZA1337	

**Basis rechteckig Form F zum einschwalben, weißfertig!**

englisch

français

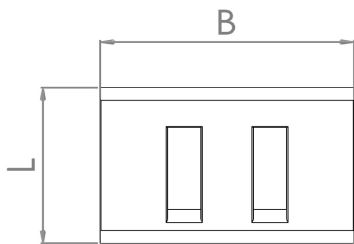

<b>B x L</b>	BH=5mm Height =5mm HM=5mm	
<b>32,00 x 21,86</b>	Z032ZA1340	

**Basis mit Bohrungen Form F zum einschwalben, brüniert!**

englisch

français

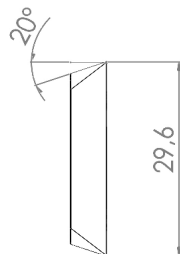
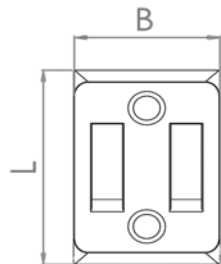

<b>B x L</b>	BH=5mm Height =5mm HM=5mm	
<b>20,00 x 29,60</b>	Z020ZA1339	

**Hakenfuß für Picatinny-Schiene!**

englisch

français

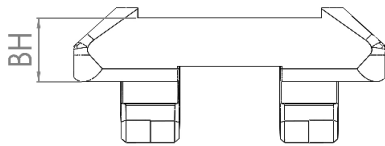

<b>Form "F" oder "N"</b>	BH=5mm Height =5mm HM=5mm	
<b>Form "F"</b>	Z050ZA3603	
<b>Form "N"</b>	Z050ZA3003	

**Schlösschen Sonderanfertigung, brüniert oder weißfertig!**

englisch

français

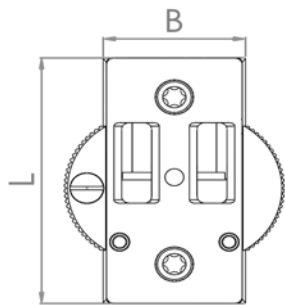

<b>B=18 (22) x L=26</b>	brüniert Gunmetal finish finition bronzée <b>B=</b> ↓	weißfertig White metal finish finition blanche <b>B=</b> ↓	
<b>Mauser K98</b>		<b>Z0 18 ZA2400</b>	

\*Weitere Modelle grundsätzlich auf Anfrage möglich!

\*Additional models also available strictly upon enquiry!

\*Autres modèles en principe possibles sur demande!

Schlösschen Contra (18mm/22mm) brüniert!  
 Contra Catch Base (18mm/22mm) in gunmetal finish!  
 Verrou Contra (18mm/22mm) finition bronzée!

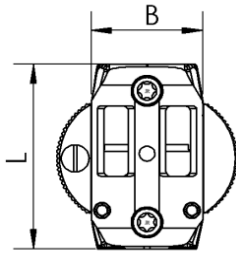

<b>B=18(22) x L=31</b> BH=5mmHeight =5mmHM=5mm	<b>B =</b> ↓	
<b>BH=5mm, Flach ohne Radius</b>	1131Z18818	

Basis Contra brüniert!  
 Contra Base in gunmetal finish!  
 Basis Contra finition bronzée!

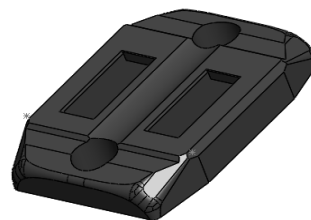
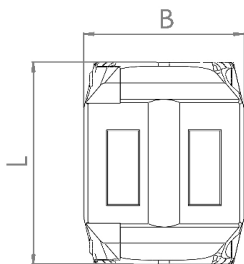

<b>B=22 x L=30</b> BH=5mmHeight =5mmHM=5mm	<b>B =</b> ↓	
<b>BH=5mm, Form "N" ohne Radius</b>	1130Z22818	
<b>BH=5mm, Form "F" ohne Radius</b>	1230Z22818	

**Klemmring für Classic und Contra brüniert!**  
**Clamping bracket for the Classic and Contra Models!**  
**Collier de serrage pour Classic et Contra!**

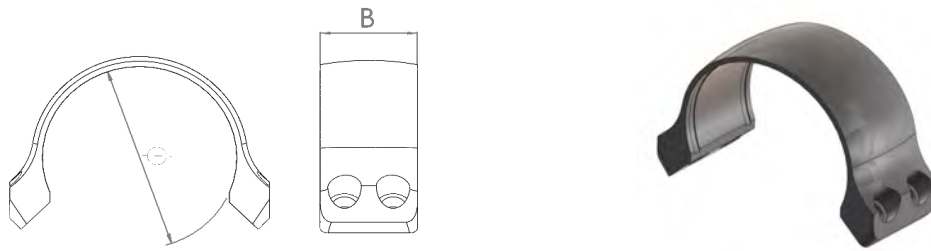

<b>Breite(mm)</b>	<b>Ø 30mm</b>	<b>Ø 1"/26mm</b>	
15,00	Z030ZA0662	Z026ZA0662	

<b>Breite(mm)</b>	<b>Ø 36mm</b>	<b>Ø 34mm</b>	
15,00	Z036ZA0662	Z034ZA0662	

**Hakenfuß mit Ring für Classic und Contra !**  
**Retro-Snap-on Mounting Shoe with bracket for the Classic and Contra Models !**  
**Pied à crochet avec collier pour Classic et Contra !**



<b>BH (mm)</b>	<b>Ø 30mm</b>	<b>1"/Ø 26mm</b>	
13,50	Z135ZA1330		

Basis für 1 Hakenfuß!  
 englisch  
 français

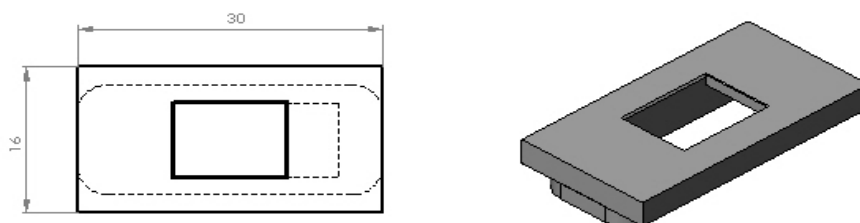

<b>B x L</b>	<b>BH=5mm</b> <b>Height =5mm</b> <b>HM=5mm</b>	
16,00 x 30,00	Z030ZA2409	



**Picatinny-schiene für Classic und Contra. BH(A) zum anpassen!**

**Picatinny rail for the Classic and Contra models, with adjustable BH(A) bracket!**

**Rail Picatinny pour Classic et Contra. Adapter à la hauteur totale de montage BH(A)!**

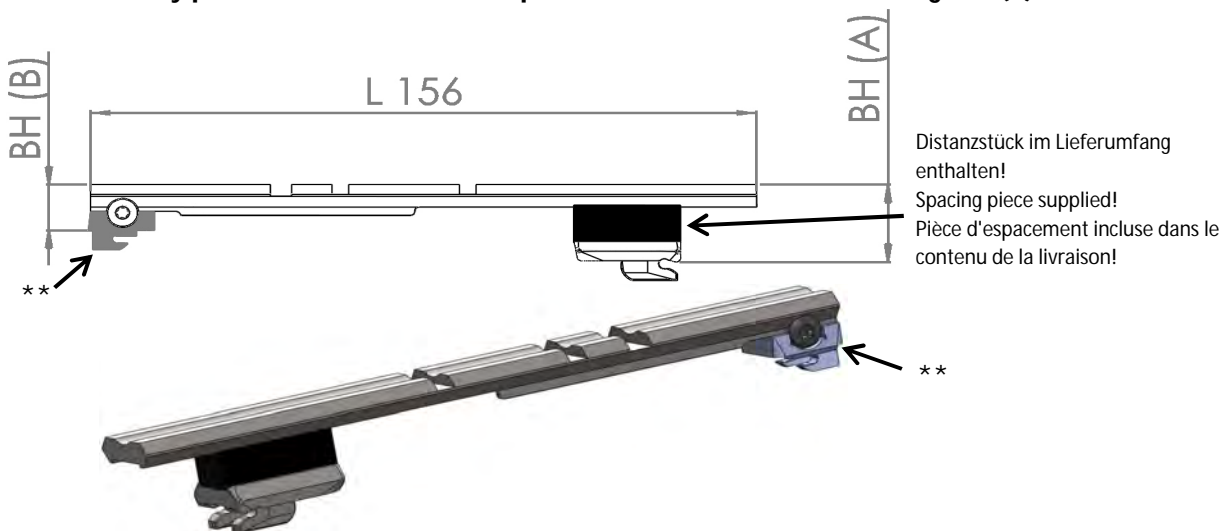

L = mm		
156mm Form N**	Z000ZA3000	
156mm Form F**	Z000ZA3600	

\*\*Auslieferung ohne Schlösschenfuß (BH(B) muss ermittelt werden) bitte separat bestellen z.B. Z050ZA0635!

\*\*supplied without the retro-snap-on foot catch (the BH(B) bracket has to be known); please order separately, e.g. Z050ZA0635!

\*\*Livraison sans embase à verrou (La hauteur totale de montage BH(B) doit être déterminée), celle-ci doit être commandée séparément par ex. Z050ZA0635!

## Ersatzteil!; Spare part!; Pièce de rechange!

**Distanzstück für Picatinny-schiene (Z000ZA3000 oder Z000ZA3600), BH zum Anpassen!**  
**Spacing piece for the Picatinny rail (Z000ZA3000 or Z000ZA3600), with adjustable BH bracket!**

**Pièce d'espacement pour rail Picatinny (Z000ZA3000 ou Z000ZA3600) à adapter à la hauteur totale de montage!**



BH	L x B	
0,00	25x2,0	Z120ZA3002
1,50	25x3,5	Z135ZA3002
2,00	25x4,0	Z140ZA3002
2,50	25x4,5	Z145ZA3002
3,00	25x5,0	Z150ZA3002
3,50	25x5,5	Z155ZA3002
4,00	25x6,0	Z160ZA3002
	25x10,0	Z100ZA3002

**Brücke für Picatinnyschiene!  
Base for picatinny rail!**

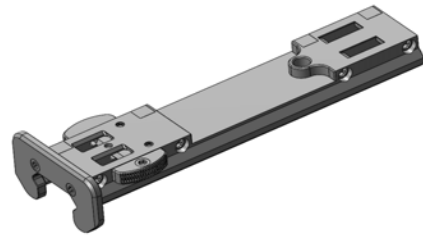
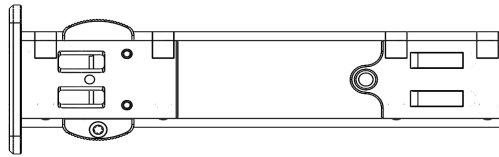

<b>L = 125,50 mm</b>		
<b>Form F**</b>	Z000ZA3700	

**Schutzhülle für Brücke Z000ZA3700!  
Cover for Base Z000ZA3700!**

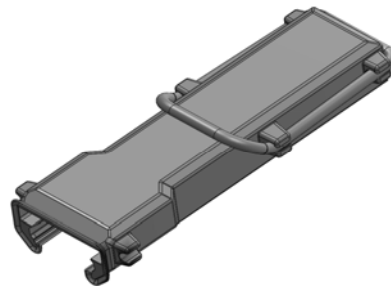
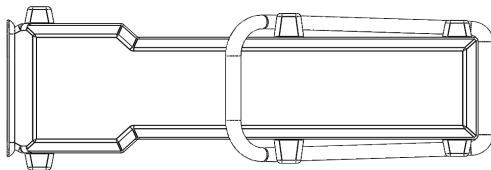

<b>L x B</b>		
<b>127mmx52mm</b>	Z000ZA3750	

**Picatinnyschiene für Artikel Z000ZA3700!  
Picatinny rail for Base Z000ZA3700!**

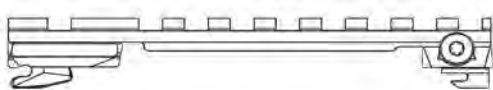

<b>L =mm</b>		
<b>106mm</b>	Z000ZA3760	

## ZP-Einhakmontage Ersatzteile

### ZP-Retro-Snap-on Mounting - Replacement Parts

### Montage à crochet ZP –Pièces de rechange

(Classic und Contra)  
(for the Classic and Contra Models)  
(Classic et Contra)

**Basis Classic für Hakenfuß weißfertig ohne Gravur!**  
**Classic Base for snap-on-shoe without scored surfaces!**  
**Basis Classic pour Pied à crochet sans gravure!**

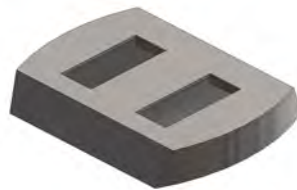
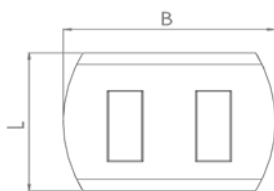

B x L		
27,00 x 21,85	Z218ZA0301	
27,00 x 23,85	Z238ZA0301	

**Supportschraube mit Schlitz brüniert!**  
**Slit-head base screw!**  
**Vis de support avec fente!**

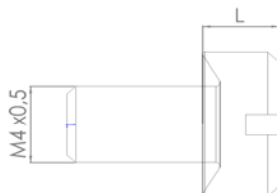

L=(mm)		
3,5mm	Z300ZD0204	
5,5mm*	Z300ZD0205	

\*Kopfhöhe « L » zum anpassen!

\*Head height adjustable « L »!

\*Hauteur de tête « L » à régler!

**Supportschraube mit Torx ISR15 brüniert!**

**Torx ISR15 base screw!**

**Vis de support avec Torx ISR15!**

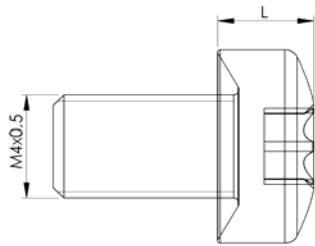

<b>L=(mm)</b>		
<b>3,5mm</b>	Z300ZD0203	

**Schraube M3,5x7,5 für Klemmringe brüniert!**

**M3 5 x 7.5 screw for clamping bracket!**

**Vis M3,5x7,5 pour collier de serrage!**

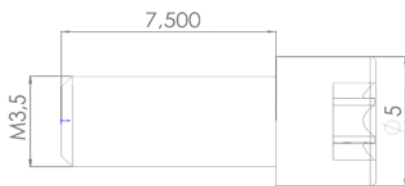

<b>Schraube Screw Vis</b>		
<b>M3,5x7,5</b>	Z075ZA0608	

**Schlösschenschraube M3,5x3 weißfertig!**

**M3 5 x 3 Catch screw!**

**Vis pour verrou M3, 5x3!**

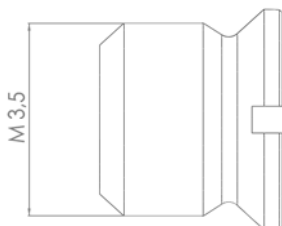

<b>Schraube Screw Vis</b>		
<b>M3,5x3,0</b>	Z000ZA0610	

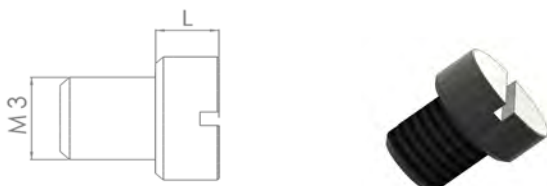
**Schieberschraube M3!****M3 Slide screw!****Vis de coulisse M3!**

<b>L=(mm)</b>		
<b>2,0mm</b>	Z020ZA0611	
<b>3,2mm*</b>	Z032ZA0611	

\*Kopfhöhe « L » zum anpassen!

\*Head height adjustable « L »!

\*Hauteur de tête « L » à régler!

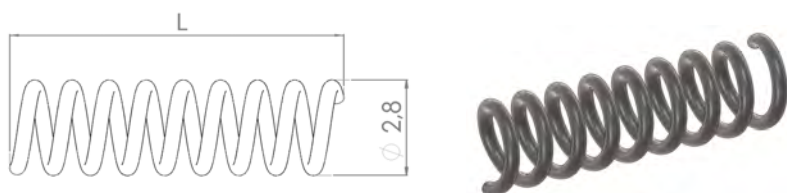
**Feder für Schlösschen Contra und Classic!****Contra und Classic Models catch spring!****Ressort pour verrou Contra et Classic!**

<b>L = mm</b>		
<b>9,0 (Classic)</b>	Z000ZA0690	
<b>8,7 (Contra)</b>	Z000ZA0687	

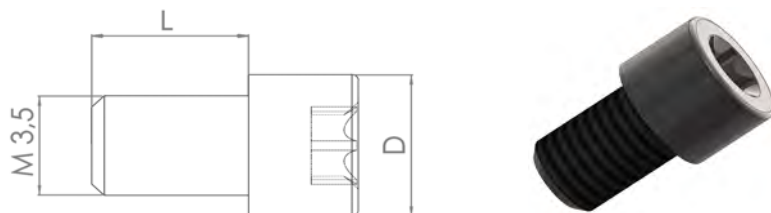
**Montageschraube M3,5 brüniert!****M3. 5 Fixing screw!****Vis de montage M3,5!**

<b>M3,5 x L x D</b>		
<b>M3,5 x 5 x 5</b>	Z050ZA0608	
<b>M3,5 x 4 x 5</b>	Z040ZA0608	
<b>M3,5 x 4 x 4</b>	Z044ZA0608	

Montageschraube UNS 6-48 brüniert!  
 UNS 6-48 fixing screw!  
 Vis de montage UNS 6-48!

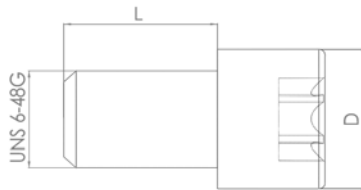

UNS 6-48G x L x D		
UNS 6-48G x 5 x 5	Z050ZA0609	
UNS 6-48G x 4 x 5	Z040ZA0609	
UNS 6-48G x 4 x 4	Z044ZA0609	
UNS 6-48G x 7,5 x 5	Z075ZA0609	

Montageschraube M4 brüniert!  
 M4 Fixing screw!  
 Vis de montage M4!

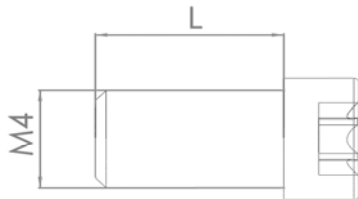

M4 x L		
M4 x 7	Z000ZA0616	

Montageschraube brüniert für: Support Zeiss, Swarovski und S&B! Hakenfuß Zeiss 45° und S&B!

'Zeiss'- 'Swarovski'- and 'S&B' fixing screw for base! 'Zeiss 45°'and 'S&B' retro-snap-on shoe!

Vis de montage pour: Support Zeiss, Swarovski et S&B! Pied à crochet Zeiss 45°et S&B!

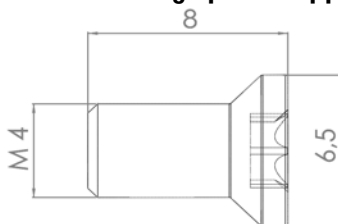

Senkschraube Counter-sunk screw Vis à tête conique		
M4x8,0	Z465ZA0080	

Montageschraube für Hakenfuß Swarovski brüniert!  
 'Swarovski' fixing screw for retro-snap-on shoe!  
 Vis de montage pour pied à crochet Swarovski!

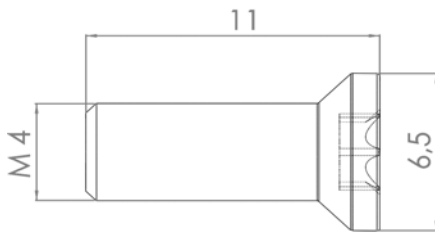

Senkschraube Counter-sunk screw Vis à tête conique		
M4x11,0	Z465ZA0110	

Senkschraube für Sako-Pratzen brüniert!  
 Claw grip counter-sunk screw!  
 Vis à tête conique pour montage Sako!



Senkschraube Counter-sunk screw Vis à tête conique		
M4x19,5	Z449ZA0195	

Montageschraube für Support Zeiss 70° brüniert!  
 'Zeiss 70°' Base Fitting Screw!  
 Vis de montage pour support Zeiss 70°!

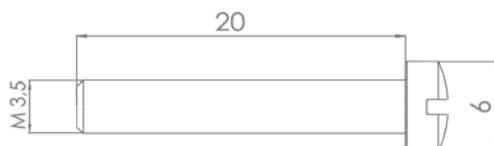

Senkschraube Counter-sunk screw Vis à tête conique		
M3,5x20,0	Z200ZA0806	

Montageset  
Fitting Set  
Set pour un montage



Montageset Fitting Set Set de montage		
5-teilig, 5-part, 5 pièces	Z900ZA0005	

Schraubendreher Torx  
Torx screw driver  
Tournevis Torx



Größe Size Dimension		
TX10	Z901ZA0001	
TX15	Z901ZA0002	

Drehmoment-Schraubendreher  
Torque spanner  
tournevis dynamométrique



Größe Size Dimension		
cNM=40-300	Z901ZA0003	



Messuhrhalter  
Gauge holder  
support du comparateur



Größe Size Dimension		
120,00	Z901ZA0004	

Messuhr  
Gauge  
comparateur



Größe Size Dimension		
3/32	Z901ZA0005	

### Ziegler Kompaktmontage (Schnittstelle Blaser) für Schienengläser



Model		
Zeiss	Z900ZA4500	
Swarovski	Z900ZA6000	
Aimpoint H2	Z900ZA4100	
DocterSight	Z900ZA4000	

### Ziegler Kompaktmontage (Schnittstelle Blaser) für Ringgläser



Ø in mm		
1" / Ø26mm	Z900ZA2600	
Ø30mm	Z900ZA3000	
Ø30mm (Höhe +3,5mm)	Z900ZA3100	
Ø34mm	Z900ZA3400	
Ø34mm (Höhe +3,5mm)	Z900ZA3410	
Ø40mm	Z900ZA4400	

### Ziegler Kompaktmontage (Schnittstelle Blaser) mit Picatinny-schiene



Model		
Picatinny-schiene	Z900ZA4600	

## Beispiele und Sonderausführungen Examples and special designs Exemples et modèles spéciaux

Aufbau Contra auf Drillinge und Kipplaufwaffen  
Contra mounting for "Drillings" and combination guns  
Montage Contra pour fusil à trois canons et armes à canons basculants

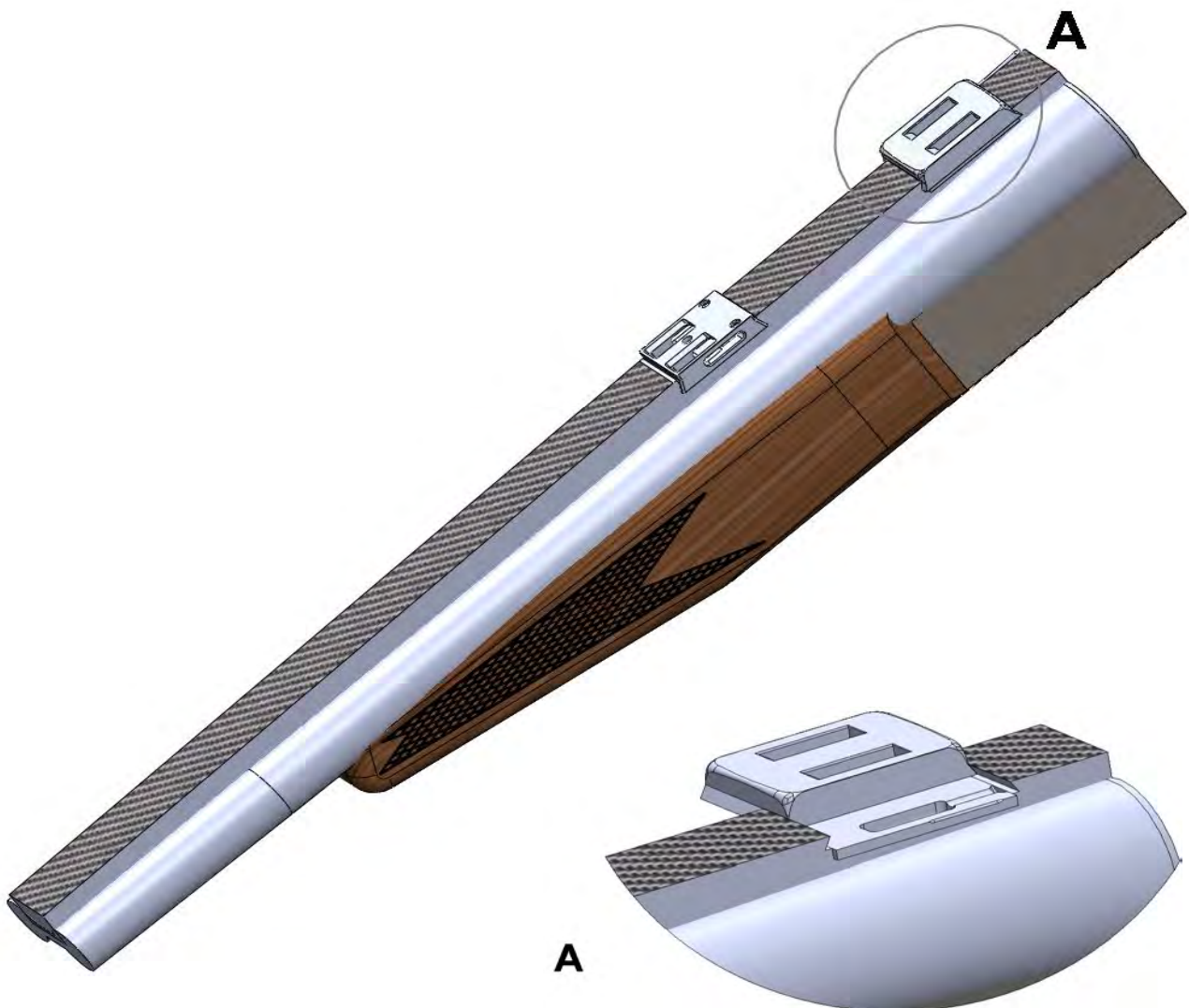

Vorhandenes altes Schlösschen halb abfräsen neue Basis z.B. Art. Nr. Z020ZA1341 einbauen!  
Cut down the existing retro-snap-on foot catch to half way and install a new base, e.g. Item  
no.: Z020ZA1341!

Anciennes serrures existantes à moitié fraisées, monter une nouvelle embase, par exemple  
n° d'article Z020ZA1341!

Expressbüchsen (Bockdoppelbüchsen) mit hoher Laufschiene  
Express hunting rifle (under-and-over double shot gun-rifle) with a high running rail  
Carabine Express (carabine à deux canons superposés) avec bande de visée plus élevée

## Silma Express



**Contra Montage in 98er System, Schlösschen aus dem vollen System gefräst (Dienstleistung für beigestelltes System)!**

**Contra mounting in the 98 System, retro-snap-on foot catch cut out of the entire system (service for the system provided)!**

**Contra Montage en système 98, serrure fraisée sur l'ensemble du système (prestation pour le système d'apport)!**



**Sonderbasis für System 98**

**Special base for the System 98**

**Embase spécialisée pour le système 98**



Schraubenlose Montagen (seitliches Klemmsystem aus hochfesten Stahl). Keine Bohrung im System nötig z. B. Sako, Sauer 303, Merkel Helix!

Screwless mounting (lateral clamping system of high-tensile steel). No drilling necessary in the system e.g. Sako, Sauer 303, Merkel Helix!

Montages sans vis (système de blocage latéral en acier très résistant). Pas de perçage nécessaire dans le système, par exemple, Sako, Sauer 303, Merkel Helix!

Merkel Helix

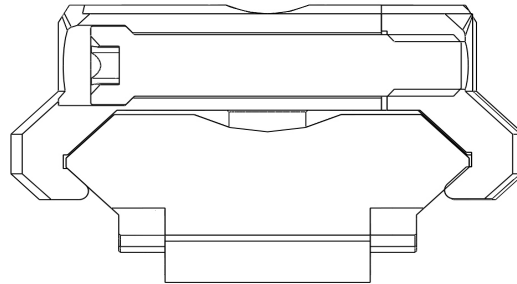

SAKO

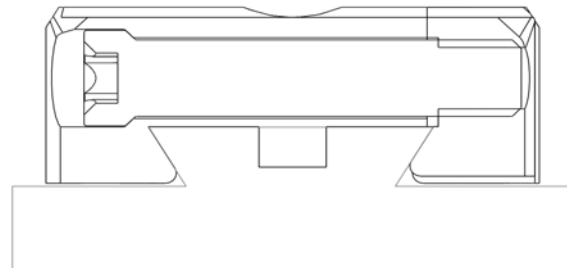
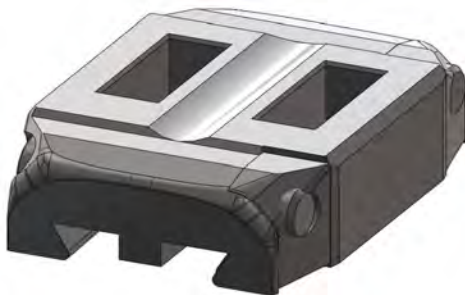

Absolut formschlüssige Verbindung, kein kleben nötig!

Absolutely interlocking fit, no adhesive required!

Jonction absolue par conjugaison de formes, aucun collage requis!



## ZIEGLER PRÄZISIONSTEILE GMBH

Handelsstraße 29

91166 Georgensgmünd

Deutschland

Tel.: +49 (0)9172 7004-0

Fax: +49 (0)9172 7004-29

Mail: [info@ziegler-praezisionsteile.de](mailto:info@ziegler-praezisionsteile.de)

[www.zp-einhakmontage.de](http://www.zp-einhakmontage.de)

